

1
HEAD

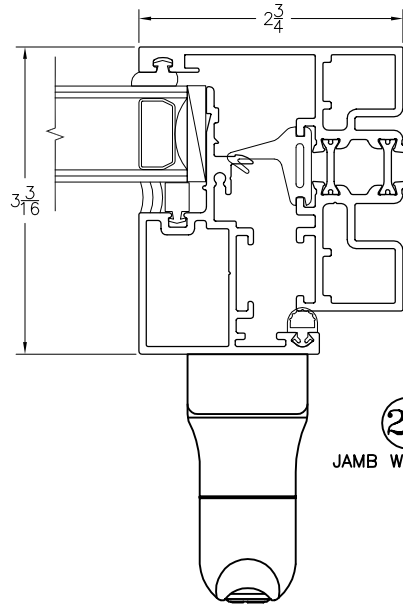

2A
JAMB W/HANDLE

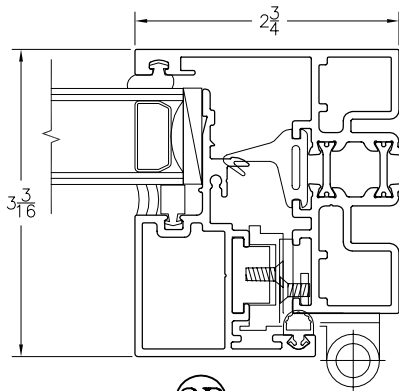

2B
JAMB W/HINGE

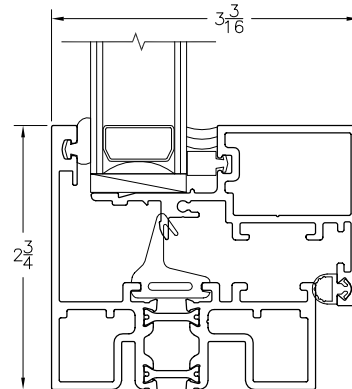

3
SILL

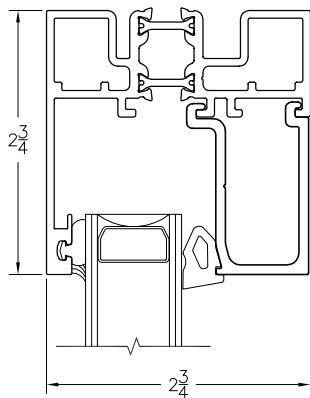

4
FIXED HEAD/JAMB

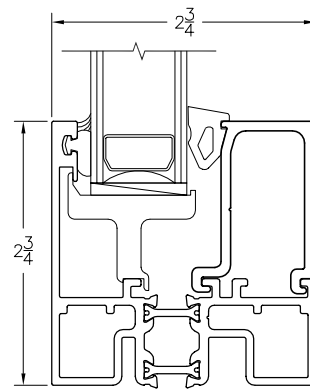

5
FIXED SILL

SCALE 1:2

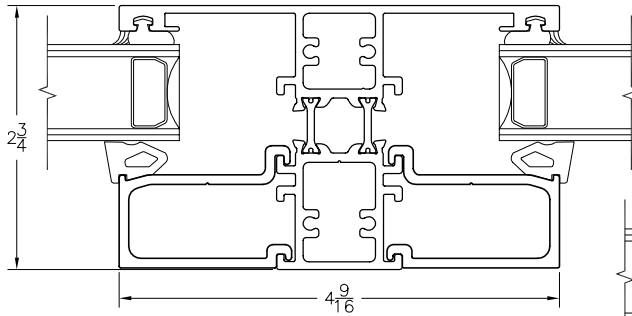

6

FX/FX T-BAR

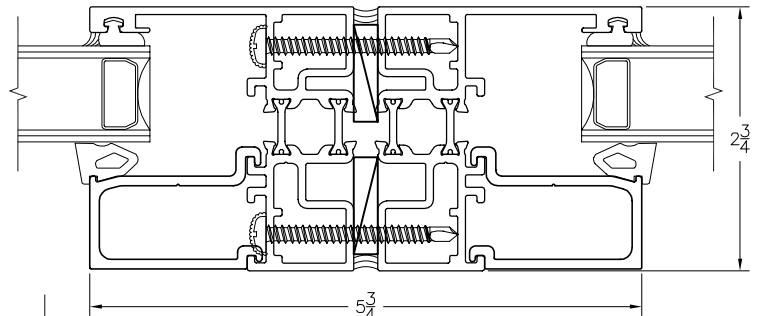

9

FX/FX MULL

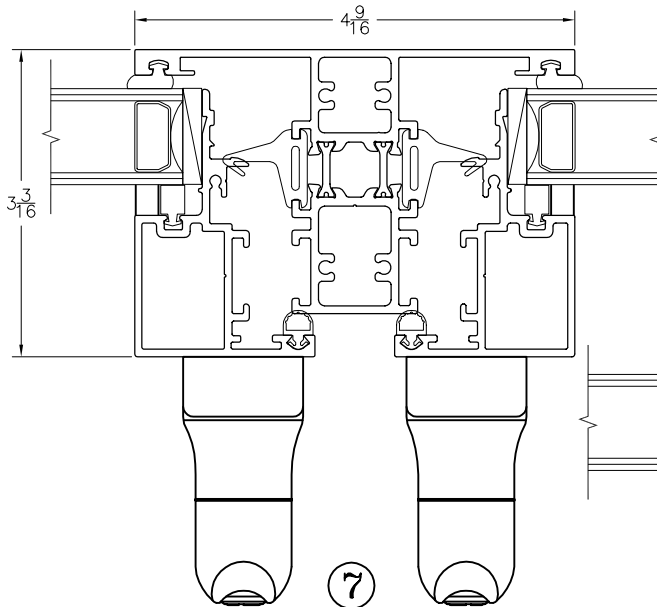

7

OP/OP T-BAR

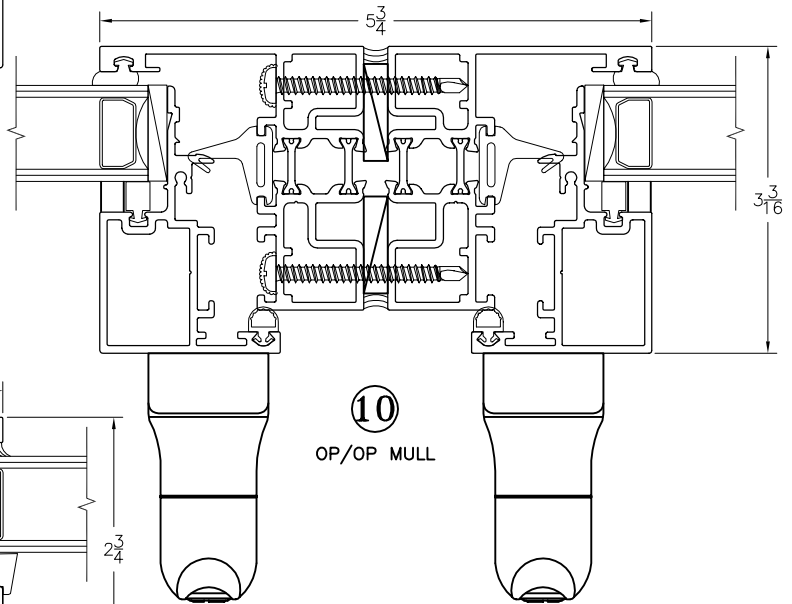

10

OP/OP MULL

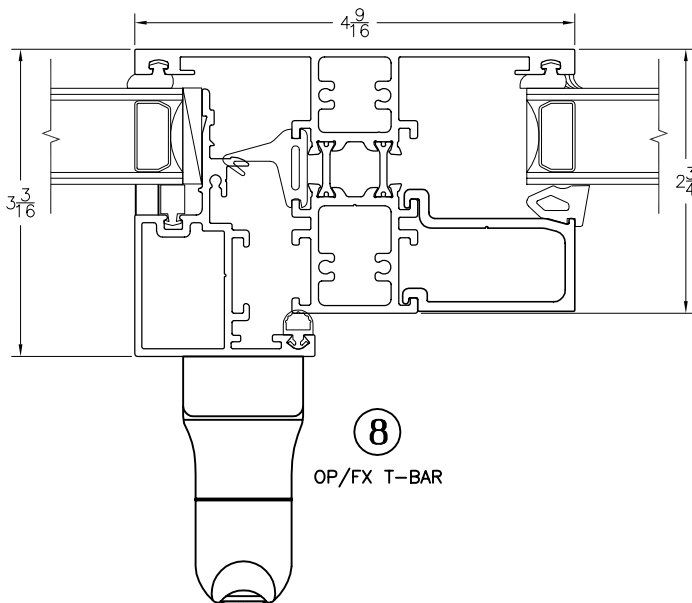

8

OP/FX T-BAR

SCALE 1:2

SG500

THESE SHOP DRAWINGS CONTAIN PROPRIETARY INFORMATION OF SKYLINE WINDOWS, LLC. THEY ARE INTENDED SOLELY FOR THE INFORMATION AND USE OF SKYLINE WINDOWS, LLC. AND THE PARTIES MENTIONED HEREIN. SUCH PROPRIETARY INFORMATION MAY NOT BE USED, REPRODUCED OR DISCLOSED TO ANY OTHER PARTIES WITHOUT THE EXPRESSED PERMISSION OF SKYLINE WINDOWS, LLC.

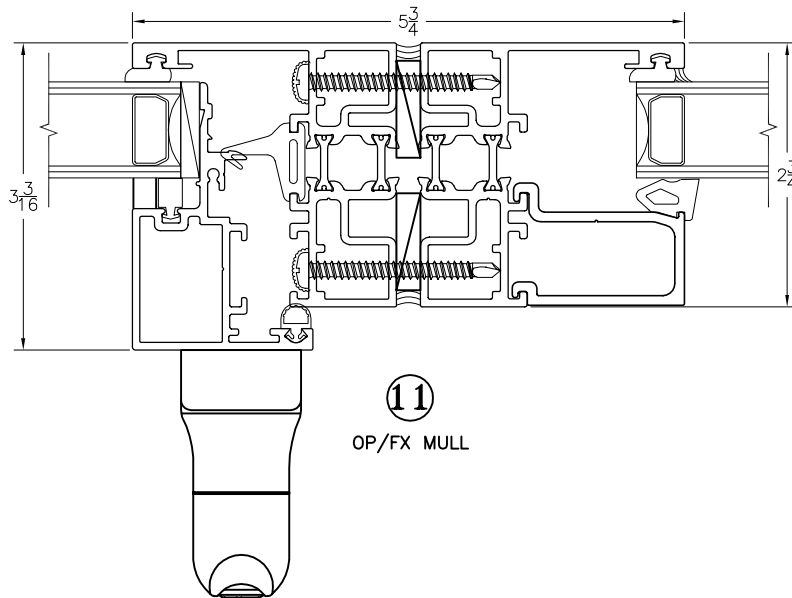

SCALE 1:2

JUNE 1, 2014